

Following information is only for EU-member states:

The use of this symbol indicates that this product may not be treated as household waste. By ensuring this product is disposed of correctly, you will help prevent potential negative consequences for the environment and human health, which could otherwise be caused by inappropriate waste handling of this product. For more detailed information about recycling of this product, please contact your local council, your household waste disposal service or the shop where you purchased the product.



T A N S U N Q U A R T Z H E A T

Reference Manual

Sorrento Ceramic Series

EUROPEAN & UK MODELS



SINGLE: SOR 210C EU, SOR 210C UK, SOR 213C EU & SOR 213C UK



DOUBLE: SOR 210DC EU, SOR 210DC UK, SOR 213DC EU & SOR 213DC UK

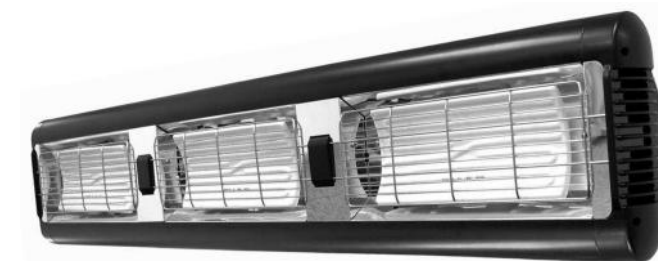

TRIPLE: SOR 210TC EU, SOR 210TC UK, SOR 213TC EU & SOR 213TC UK



T A N S U N L I M I T E D

Spectrum House, Unit 1, Ridgacre Road, West Bromwich,
West Midlands, B71 1BW, England.

Tel: +44 (0)121 580 6200 - Fax: +44 (0)121 580 6222

Email: quartzinfo@tansun.com - Website: www.tansun.com

Introduction

The Tansun range of Sorrento Ceramic heaters contain long-life ceramic elements which are highly efficient and durable. They produce radiant heat like the sun, warming people and objects rather than the air in between. The heaters are mounted on an adjustable bracket that allows the heat to be directed exactly where it is required. Its attractive, lightweight design means that it is effective yet unobtrusive. The Sorrento Ceramic heaters are designed for indoor use.

Please read the following instructions carefully before use. The safety of this heater is guaranteed only by its correct usage in accordance with these instructions, therefore it is recommended that they are retained for future reference.

Caution

- Before using this appliance:
 - Check that the voltage indicated on the type plate corresponds to the mains supply voltage.
 - Ensure that the heater has been securely fastened in its final mounting position.
- Do not locate the heater immediately below a socket outlet.
- Remove the plug from the mains socket (or disconnect pole switch) during installation, cleaning and/or replacing the element and always ensure that the element is cool.
- Do not use an extension cable with this product because the extension cord may overheat and cause a risk of fire.
- Keep the mains cable away from the body of the heater which will get hot during use.
- Do not cover or obstruct the heater while it is in use.
- This appliance is not intended for use by persons (including children) with reduced physical, sensory or mental capabilities, or lack of experience and knowledge, unless they have been given supervision or instruction concerning use of the appliance by a person responsible for their safety. Children should be supervised to ensure that they do not play with the appliance.
- Do not insert any object through any slot or opening in the heater.
- Do not use if guard is not present.
- Do not install less than the minimum mounting distance from the floor.
- **WARNING:** This heater is not equipped with a device to control the room temperature. Do not use this heater in small rooms when they are occupied by persons not capable of leaving the room on their own, unless constant supervision is provided.
- This heater is for indoor use only - do not install outdoors or use the heater in a damp area, for example a bathroom or near to a swimming pool.
- **WARNING:** This appliance must be connected to a supply that is earthed! 

Risk of Fire

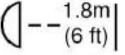
Keep combustible materials such as furniture, papers, clothes and curtains at least 1.8m (6 feet) from the front of the heater and away from the sides and rear. If the heater is to be used outside, we recommend that a waterproof or indoor socket is used. 

Specification

Table 1. UK and European Heaters

Model	Voltage (V)	No. of Elements x Power (kW)	Total Power (kW)	Current (A) per Element	Total Current (A) of unit	Min. height from floor (m)	Min. dist. from ceiling (m)	Min. dist. from side wall (m)	Dimensions (inc. bracket in max. pos.) W x H x D (mm)	Weight (kg)
SOR 210C	230	1 x 1.0	1.0	4.3	4.3	2.1	0.3	1.5	430 x 228 x 323	3.7
SOR 213C	230	1 x 1.3	1.3	5.7	5.7	2.1	0.3	1.5	430 x 228 x 323	3.7
SOR 210DC	230	2 x 1.0	2.0	4.3	8.7	2.5	0.5	1.5	815 x 228 x 323	5.9
SOR 213DC	230	2 x 1.3	2.6	5.7	11.3	3.0	0.5	1.5	815 x 228 x 323	5.9
SOR 210TC	230	3 x 1.0	3.0	4.3	13.0	3.0	0.5	1.5	1202 x 228 x 323	8.3
SOR 213TC	230	3 x 1.3	3.9	5.7	17.0	3.5	0.5	1.5	1202 x 228 x 323	8.3

Use MCB Type 3.

Installation

- Warning - this appliance must be connected to an earthed supply. 
- All versions are fitted with 5.0 metres of supply cable and a moulded plug, therefore it is unnecessary to remove the terminal box in order to carry out normal installation of these models.
- We recommend the heaters are plugged into a socket with an indicator light to visibly show when the heater is switched on.
- All installations must be in accordance with the latest I.E.E. safety regulations or equivalent.
- We recommend using a RCD where applicable.
- If the supply cord becomes damaged, it must be replaced by the manufacturer, its service agent or a similar qualified person in order to avoid a hazard.
- Please observe the minimum safe distance between the heater body and any inflammable surfaces.
- If in any doubt, please contact a suitably qualified electrician.
- To disconnect heater, remove the mains plug from the socket outlet.

10. The element should now be completely removed from the reflector as shown below in Fig. S and the new element can be fitted in reverse as the old one that was removed. Use the new spring clip and retaining clip as supplied with the new element and ensure the retaining clip is pushed all the way along the spring clip.

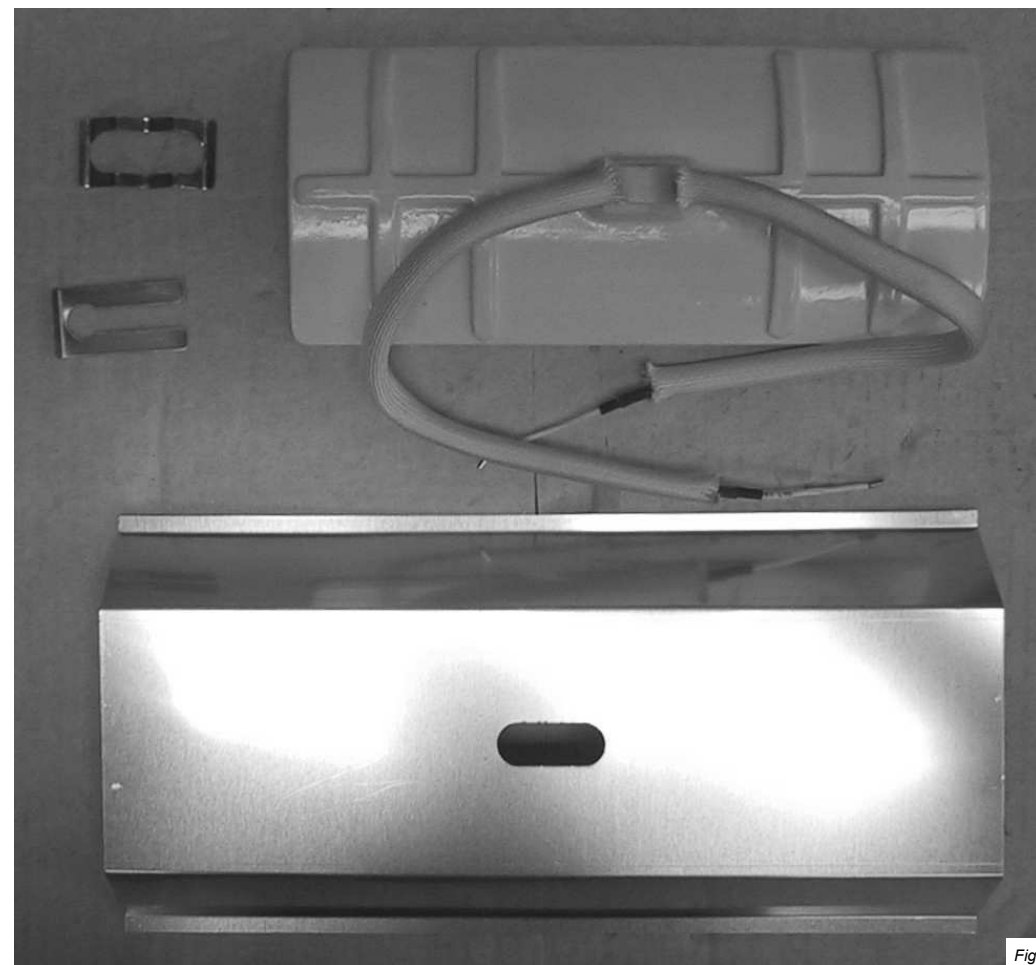

Fig. S

11. Refit the parts in reverse order ensuring no wires become trapped and all screws are fully tightened. Return the heater to its final mounting position before connecting to the mains supply.

8. The reflector can now be gently lifted past the side reflector screws (Fig. P) and out of the heater completely.



Fig. P

9. Place the reflector face down on a flat surface and push the element retaining clip by the raised edge in the direction shown in Fig. Q until it releases from the assembly as shown in Fig. R and remove the spring clip by passing it over the element wires.

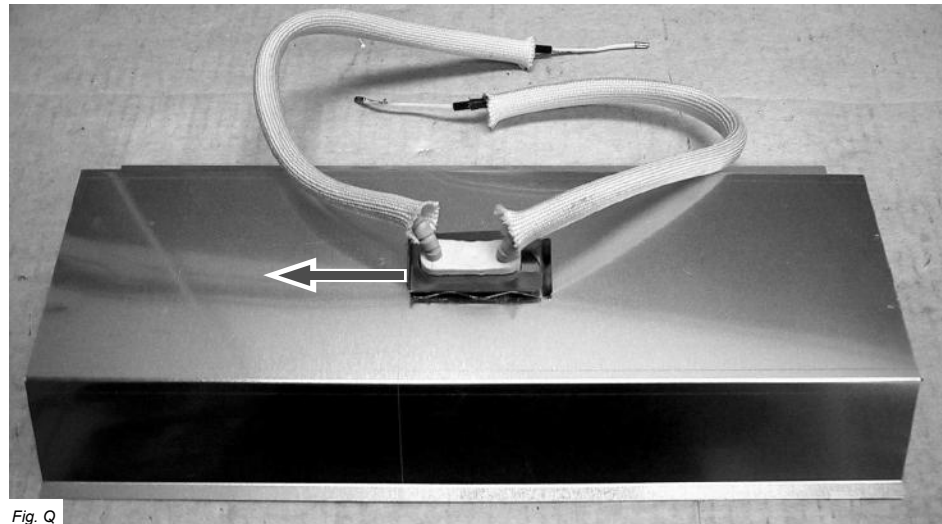

Fig. Q

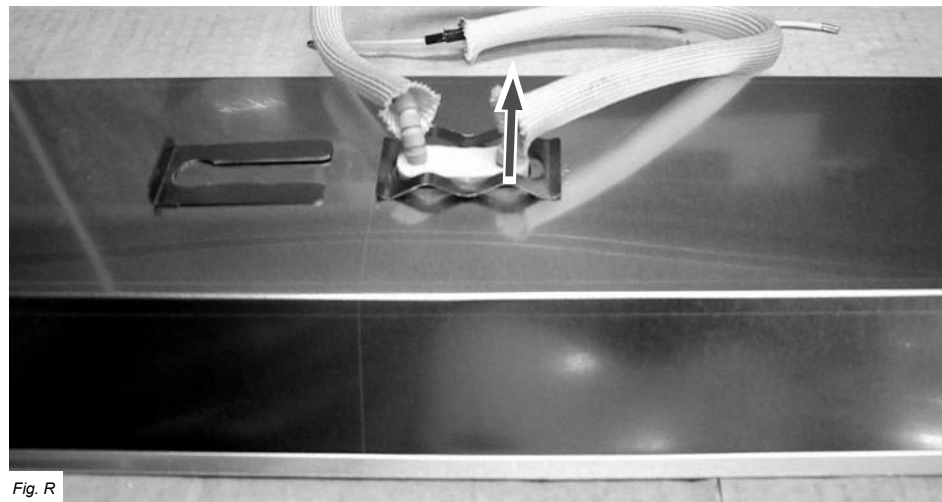

Fig. R

Wall Mounting

- The Sorrento Ceramic heaters can be wall mounted in a horizontal manner.
- When wall mounting the Sorrento Ceramic heater, do not position the heater at an angle more than 90° and less than 30° as shown in Fig. A.
- Always allow the heater to cool before attempting to reposition/move. Never attempt to move the heater while it is switched on!
- Observe the minimum safe distance between the heater body and inflammable surfaces and objects when mounting.
- Please refer to Table 1 for the recommended positioning of the heater with regards to minimum distances. **Do not install the heater in a corner!**
- Keep out of the reach of children.

All Models

1. When wall mounting, securely fasten the L-shaped wall brackets to the mounting surface using both of the fixing holes in the short part of the bracket (see Fig. B for mounting hole centres of the Single unit, Fig. C for the Double and Fig. D). Refer to Table 1 for recommended positioning of the heater. Please note: wall fixings are not supplied. They should be selected to substantially support the weight of the installation. If in doubt contact a professional for advice!
2. The heater can be offered up to the mounted brackets and fixed securely with the nuts and bolts provided as shown in Fig. E.
3. The heater should be mounted with the terminal box at the bottom of the heater when being wall mounted.
4. When wall mounting, fix in the required angular position by tightening the fixing bolts on the brackets at the rear of the heater as shown in Fig. E.
5. Secure the supply cable so it is not resting on the body or obstructing the air-vents.

Always isolate the heater from the mains supply when adjusting the position.

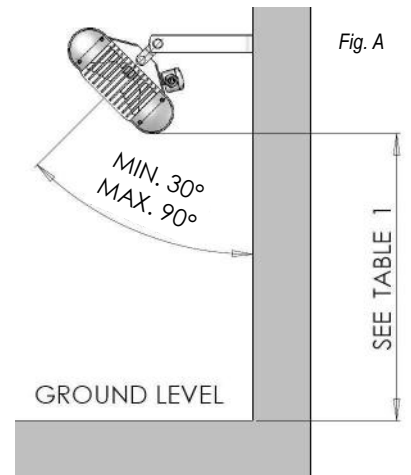

DRILLING HOLE TEMPLATE DIMENSIONS FOR WALL MOUNTED BRACKETS - SINGLE UNIT

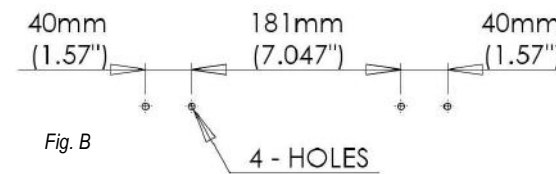

Fig. B

DRILLING HOLE TEMPLATE DIMENSIONS FOR WALL MOUNTED BRACKETS - DOUBLE UNIT

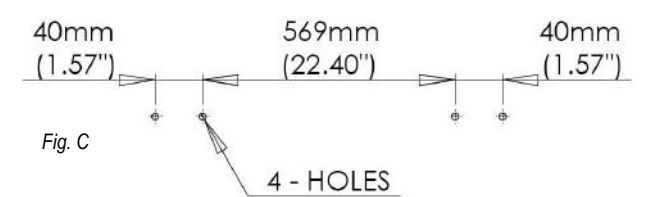

Fig. C

DRILLING HOLE TEMPLATE DIMENSIONS FOR WALL MOUNTED BRACKETS - TRIPLE UNIT

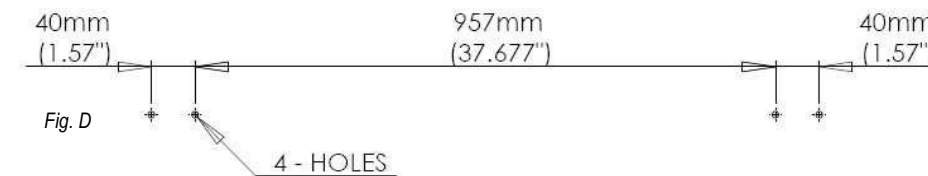

Fig. D

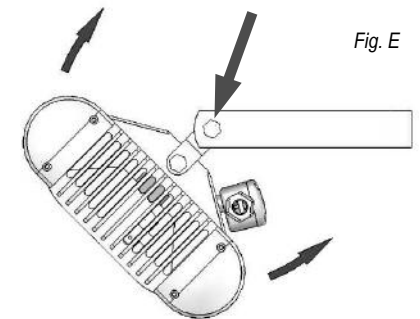

Fig. E

Single with Optional Swivel Bracket

1. When wall mounting, securely fasten the L-shaped wall bracket to the mounting surface using both of the fixing holes in the short part of the bracket. Refer to Table 1 for recommended positioning of the heater. Please note: wall fixings are not supplied. They should be selected to substantially support the weight of the installation. If in doubt contact a professional for advice!
2. The heater can be fixed to the wall bracket securely with the nuts and bolts provided as shown in Fig. F.
3. The heater should be mounted with the terminal box at the bottom of the heater.
4. When wall mounting, fix in the required angular position by tightening the fixing bolts on the brackets at the rear of the heater as pointed out in Fig. F.
5. Secure the supply cable so it is not resting on the body or obstructing the air-vents.

Always isolate the heater from the mains supply when adjusting the position.

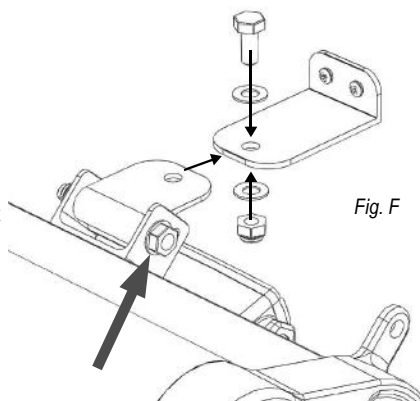

Fig. F

Chain Hanging - All Models

- The Sorrento Ceramic heaters can be chain hung from a ceiling.
 - When ceiling hanging the Sorrento Ceramic heater, ensure the minimum distance from the ceiling is adhered to as shown in Fig. G. and maintain the minimum distance to the floor.
 - Please refer to Table 1 for the recommended positioning of the heater with regards to minimum distances. **Do not install the heater in a corner!**
 - Always allow the heater to cool before attempting to reposition/move. Never attempt to move the heater while it is switched on!
 - Observe the minimum safe distance between the heater body and inflammable surfaces and objects when mounting.
 - Keep out of the reach of children.
- Please refer to Table 1 for recommended positioning of the heater. When hanging from a ceiling, two chains of equal length and gauge are required and should be used with fixings that are adequate to hold the weight of the heater. If in doubt contact a professional for advice!
 - Attach the heater assembly to the chains via the hole in the centre of the end cap as shown in Fig. G. and ensure the heater faces directly down when hanging.
 - Secure the supply cable so they do not rest on the body or obstruct the air-vents.

Always isolate the heater from the mains supply when adjusting the position.

Maintenance

In the event of heater failure, or for spare parts or advice, please contact the manufacturer or your service agent.

- Disconnect from the mains by removing all plugs from the main sockets before commencing any maintenance procedure including cleaning.
- To ensure optimum heat effectiveness, it is recommended that the guard is removed and the reflector is wiped with a lint-free cloth should the reflector show considerable signs of dust or dirt.

Replacing the Element

If you are in any doubt about following the procedure below, please contact us for technical assistance. The mains power should be disconnected before any attempts are made to replace the lamp. The following should be carried out with compliance to the latest IEE regulations. If you are unfamiliar with installing such fixtures, contact a qualified electrician to carry it out.

- Ensure the heater and element are cool and the power supply is disconnected by removing the plug(s) from the socket outlet - **all plugs must be removed** even if only one element is to be replaced on a Double or Triple model.
- Remove the screws from the terminal box at the back of the element you wish to replace and lift off the lid - see Fig. H.



Fig. H

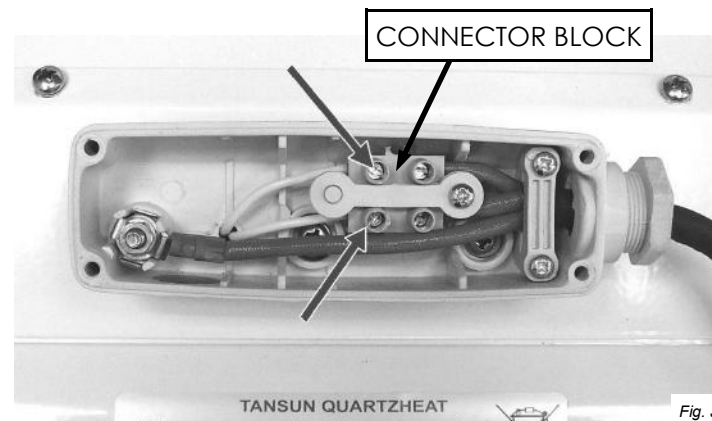

Fig. J

- Disconnect the element from the connector blocks by unscrewing the screws highlighted above in Fig. J and remove the white coloured element wires from the connector block.
- At the back of the heater, remove the terminal box holding plate by removing the two fixing screws as shown in Fig. K.

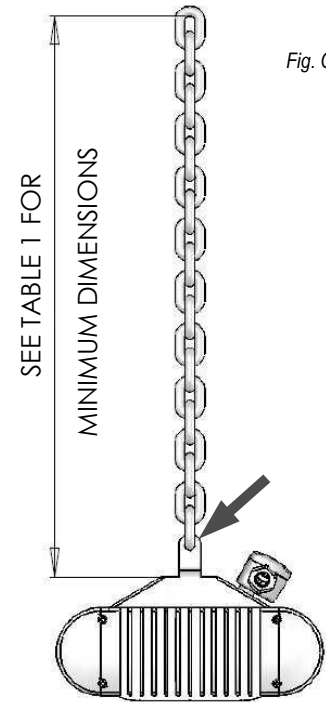

Fig. G

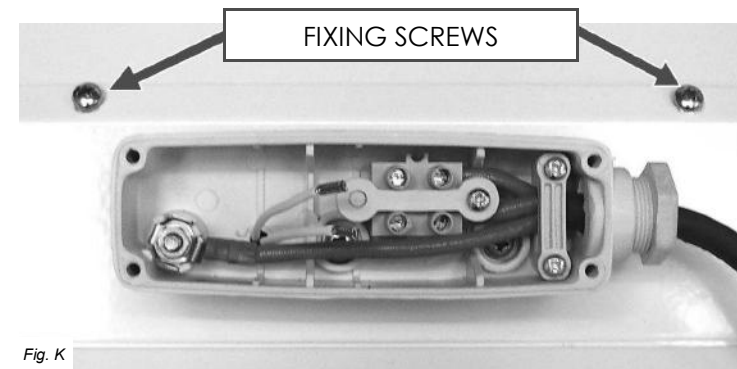

Fig. K

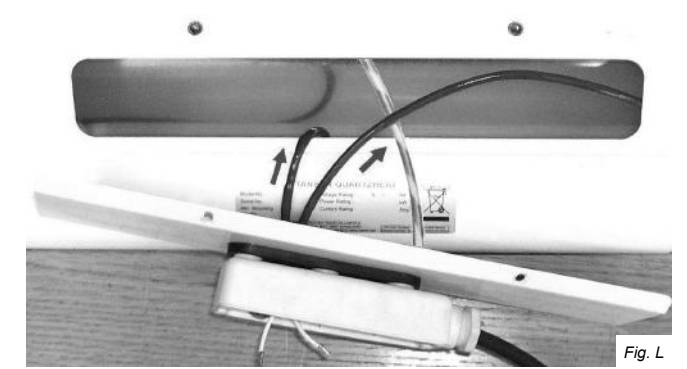

Fig. L

- Pull the element wires one at a time through the plate to remove as shown in Fig. L.

- At the front of the heater, the guard in front of the element you are replacing should be removed by gently pulling it away from the heater so it pries out of its locating holes at each end (Fig. M).



Fig. M

- From the back of the heater, gain access to the inside through the terminal plate hole and squeeze the furthest angled face of the reflector towards the hole to release it from the channel (Fig. N). Push the other side angled face of the reflector to completely release it from the heater body.

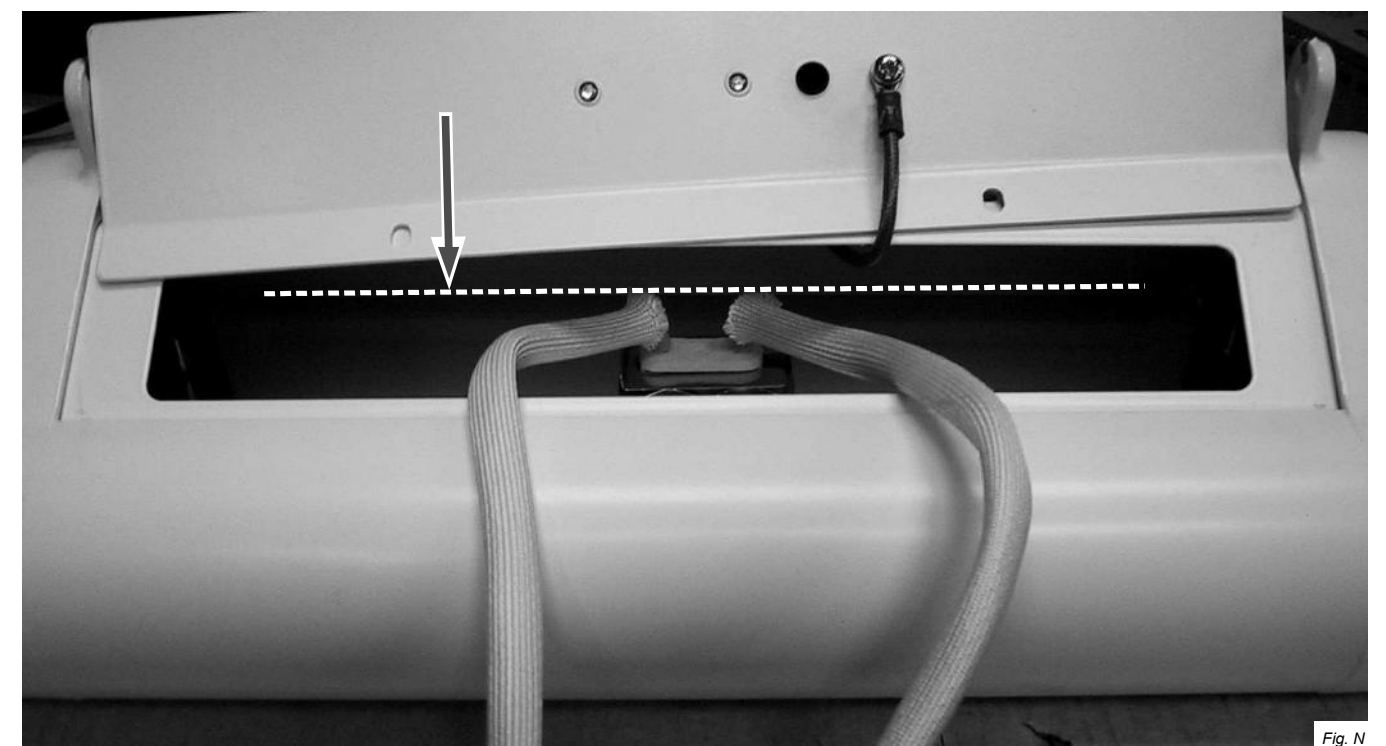

Fig. N